

CLARKE®



BUFFER/POLISHER

MODEL NO: CBB150

PART NO: 6500485

OPERATION & MAINTENANCE INSTRUCTIONS



ORIGINAL INSTRUCTIONS

GC11/20-REV 2

INTRODUCTION

Thank you for purchasing this CLARKE buffer/polisher. Before attempting to use this product, please read this manual thoroughly and follow the instructions carefully. In doing so you will ensure the safety of yourself and that of others around you, and you can look forward to your purchase giving you long and satisfactory service.

SPECIFICATIONS

	CBB150
Motor Power	250W
Fuse Rating	5 Amp
Rated Voltage / Frequency	230V / 50Hz
Shaft Diameter	12.7 mm
No Load Speed	2850 rpm
Wheel Diameter	150 mm
Dimensions	210 x 480 x 220 mm
Weight	8.9 kg

GUARANTEE

This product is guaranteed against faulty manufacture for a period of 12 months from the date of purchase. Please keep your receipt which will be required as proof of purchase.

This guarantee is invalid if the product is found to have been abused or tampered with in any way, or not used for the purpose for which it was intended. Faulty goods should be returned to their place of purchase, no product can be returned to us without prior permission. This guarantee does not effect your statutory rights.

ENVIRONMENTAL PROTECTION



Through purchase of this product, the customer is taking on the obligation to deal with the WEEE in accordance with the WEEE regulations in relation to the treatment, recycling & recovery and environmentally sound disposal of the WEEE.

In effect, this means that this product must not be disposed of with general household waste but according to the laws governing Waste Electrical and Electronic Equipment (WEEE) at a recognised disposal facility.

POWER TOOL SAFETY WARNINGS

WORK AREA

1. **Keep the work area clean and well lit.** Cluttered and dark areas invite accidents.
2. **DO NOT operate power tools in explosive atmospheres, such as in the presence of flammable liquids, gases or dust.** Power tools create sparks which may ignite the dust or fumes.
3. **Keep children and bystanders away while operating a power tool.** Distractions can cause you to lose control.

ELECTRICAL SAFETY

1. **Power tool plugs must match the outlet. Never modify the plug in any way. Do not use adapter plugs with earthed (grounded) power tools.** Unmodified plugs and matching outlets will reduce the risk of electric shock.
2. **DO NOT expose power tools to rain or wet conditions.** Water entering a power tool will increase the risk of electric shock.
3. **DO NOT abuse the power cable. Never use it for carrying, pulling or unplugging the power tool. Keep the power cable away from heat, oil, sharp edges or moving parts.** Damaged or entangled cables increase the risk of electric shock.
4. **When operating a power tool outdoors, use an extension cable suitable for outdoor use.** Use of a cable suitable for outdoor use reduces the risk of electric shock.
5. **If operating the power tool in a damp location is unavoidable, use a residual current device (RCD) protected supply.**

PERSONAL SAFETY

1. **Stay alert, watch what you are doing and use common sense when operating a power tool.** Do not use a power tool while you are tired or under the influence of drugs, alcohol or medication. A moment of inattention while operating power tools may result in personal injury.
2. **Use safety equipment. Always wear eye protection.** Safety equipment such as dust mask, non-skid safety shoes, hard hat, or hearing protection used for appropriate conditions will reduce personal injuries.
3. **Avoid accidental starting.** Ensure the switch is in the off position before plugging in. Carrying power tools with your finger on the switch or plugging in power tools that have the switch on invites accidents.

4. **Remove any wrench before turning the power tool on.** A wrench left attached to a rotating part may result in personal injury.
5. **DO NOT overreach.** Keep proper footing and balance at all times. This enables better control of the power tool in unexpected situations.
6. **Dress properly.** Do not wear loose clothing or jewellery. Keep your hair, clothing and gloves away from moving parts. Loose clothes, jewellery or long hair can be caught in moving parts.

POWER TOOL USE AND CARE

1. **DO NOT** force the power tool. Use the correct accessories for your application. The correct power tool will do the job better and safer at the rate which it was designed.
2. **DO NOT use the power tool if the switch does not turn it on and off.** Any power tool that cannot be controlled with the switch is dangerous and must be repaired.
3. **Disconnect the plug from the power source before changing accessories, or storing power tools.** Such preventive safety measures reduce the risk of starting the power tool accidentally.
4. **Store idle tools out of the reach of children and do not allow persons unfamiliar with the power tool or these instructions to operate it.** Power tools are dangerous in the hands of untrained users.
5. **Maintain power tools.** Check for misalignment or binding of moving parts, breakage of parts and any other condition that may affect the power tool's operation. If damaged, have the power tool repaired before use. Many accidents are caused by poorly maintained power tools.
6. **Use the power tool and accessories in accordance with these instructions and in the manner intended, taking into account the working conditions and the work to be performed.** Use of the power tool for operations different from intended could result in a hazardous situation.
7. The performance of this tool may vary, depending upon variations in line voltage. Extension cable usage may also affect performance.

SERVICING





1. **Have your power tool serviced by qualified service personnel using only identical replacement parts.** This will ensure that the safety of the power tool is maintained.

BUFFER/POLISHER SPECIFIC WARNINGS

1. **DO NOT** get the buffer/polisher wet or use in damp or wet locations.

2. **DO NOT** switch the buffer/polisher on whilst the wheel is in contact with the workpiece.
3. Avoid polishing dissimilar metals with the same buffing wheel; galvanic corrosion may occur.
4. **DO NOT** touch the workpiece immediately after polishing as it may be very hot.
5. **DO NOT** touch the buffing wheel whilst operating or whilst plugged into the mains power.
6. **DO NOT** leave the buffer/polisher running unattended.
7. **DO NOT** operate the buffer/polisher when you are tired or under the influence of alcohol, drugs or intoxicating medication.
8. When not in use, switch the buffer/polisher off and remove the plug from the power supply.

SAFETY SYMBOLS

	Read the manual and safety instructions before use			Eye protection should be worn
	Ear protection should be worn			Dust mask should be worn
	HAZARD, Motor gets hot			

The above safety symbols are displayed on the machine.

ELECTRICAL CONNECTIONS



WARNING: READ THESE ELECTRICAL SAFETY INSTRUCTIONS FULLY BEFORE CONNECTING THE PRODUCT TO THE MAINS SUPPLY.

This product is provided with a standard 13 amp, 230 volt (50Hz), BS 1363 plug, for connection to a standard, domestic electrical supply. Should the plug need changing, make sure that a plug of identical specification is used.



**WARNING: THE WIRES IN THE CABLE ARE COLOURED AS FOLLOWS:
BLUE = NEUTRAL BROWN = LIVE YELLOW AND GREEN = EARTH**

If the colours of the wires in the power cable do not correspond with the markings on the terminals of your plug, proceed as follows.

- Connect the **blue** wire to the terminal which is marked **N**.
- Connect the **brown** wire to the terminal which is marked **L**.
- Connect the **yellow and green** wire to the terminal which is marked **E** or \perp .
- See the specification table for the correct fuse size.

Plug must be BS1363/A approved.

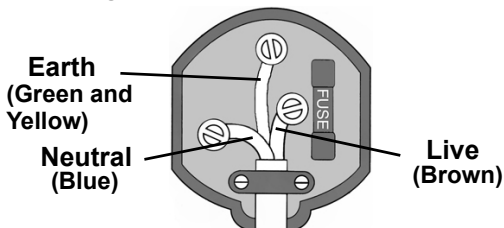

make sure that the outer sheath of the cable is firmly held by the clamp

AN APPROVED RESIDUAL CURRENT DEVICE (RCD) WHICH HAS A TRIPPING CURRENT OF LESS THAN 30MA MUST BE USED.

If you are not sure, consult a qualified electrician. DO NOT try to do any repairs.

ASSEMBLY

MOUNTING THE MACHINE

1. Bolt the buffer/polisher to a workbench using the securing holes shown.
 - Check that all assembly nuts and bolts are secure before turning the machine on.
 - DO NOT block the ventilation paths through the base.

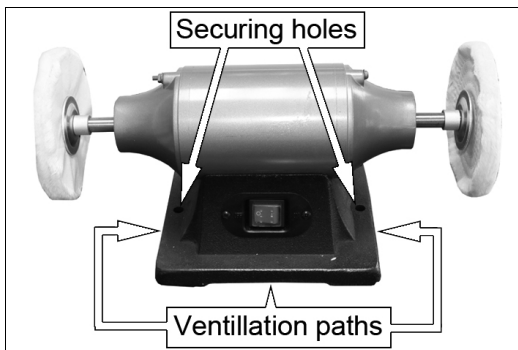

FITTING BUFFING/POLISHING PADS

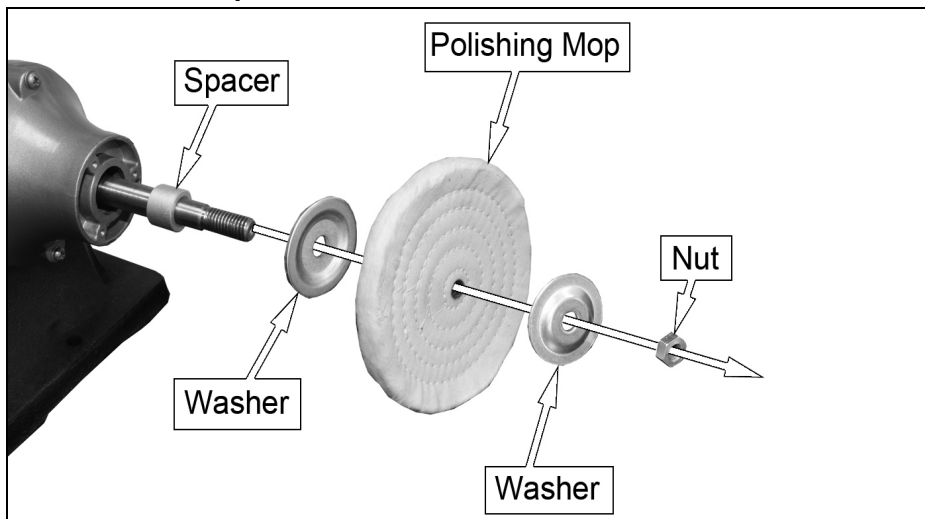

1. Place the spacer over the shaft.
2. Place the polishing mop between the washers and secure with the retaining nut, hand tight.
 - The shaft threaded ends are handed LH and RH.
3. Tighten the nuts enough to grip without crushing the buffing/polishing pad.

NOTE: Wheel rotation, in use, will tighten the retaining nut.

USING YOUR BUFFER/POLISHER



WARNING: BEFORE COMMENCING WORK, ENSURE YOU HAVE READ AND UNDERSTOOD ALL OF THE SAFETY INSTRUCTIONS

1. Plug the buffer/polisher into the mains power supply.
2. Switch the buffer/polisher on
3. Slowly bring the workpiece into contact with the polishing mop.

- See the image on the right to determine the safest and best position for contact with the wheel.
- DO NOT contact the wheel outside of the quadrant.

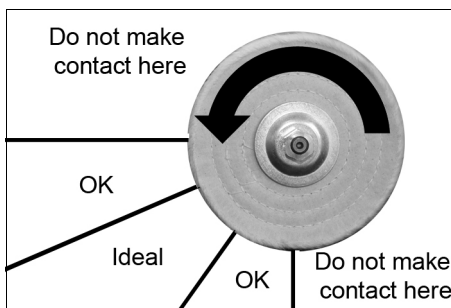

4. After use, unplug the buffer/polisher from the mains power supply, and clean the machine ready for next use.
-

MAINTENANCE



WARNING: MAKE SURE THAT THE BUFFER/POLISHER IS UNPLUGGED FROM THE MAINS POWER SUPPLY BEFORE PERFORMING ANY MAINTENANCE.

1. Regularly inspect the buffing/polishing pad. Replace when worn.
2. Keep the buffer/polisher clean and dry. DO NOT use abrasives.
3. The motor and bearing are sealed units and require no maintenance.

CLEANING & STORAGE

1. Clean the exterior the machine if required using a mild detergent or mild solvent.
2. Never immerse the buffer/polisher in water.
3. Keep any cooling vents in the buffer/polisher free of debris.

REPLACEMENT POLISHING MOPS

	TYPE	PART No
150 mm REPLACEMENT POLISHING MOPS	OPEN	6500486
	STITCHED	6500487

COMPONENT PARTS

1	Nut M12 (Left-hand tread)
2	Retaining disc
3	Less thread buffing wheel
4	Spacer bush
5	Nut M5
6	End cap
7	Corrugated retainer
8	Bearing 6202
9	Power cable & plug
10	Rubber sleeve
11	Multi-wire cloth buffing wheel
12	Rotor
13	Nut M12
14	Stator
15	Philips screw & washer M5x200
16	Ext tooth lock washer
17	Philips screw & washer M4x8

18	Power cable gland
19	Switch
20	Philips screw M5x8
21	Switch board
22	Base
23	Nut M8
24	Capacitor bracket
25	Capacitor
26	Philips screw & washer M6x20
27	Base plate
28	Rubber foot
29	Philips screw & washer M4x12
30	Cable clip baseplate
31	Philips screw M6 x 16
32	Strain relief baseplate
33	Strain relief plate

COMPONENT PARTS

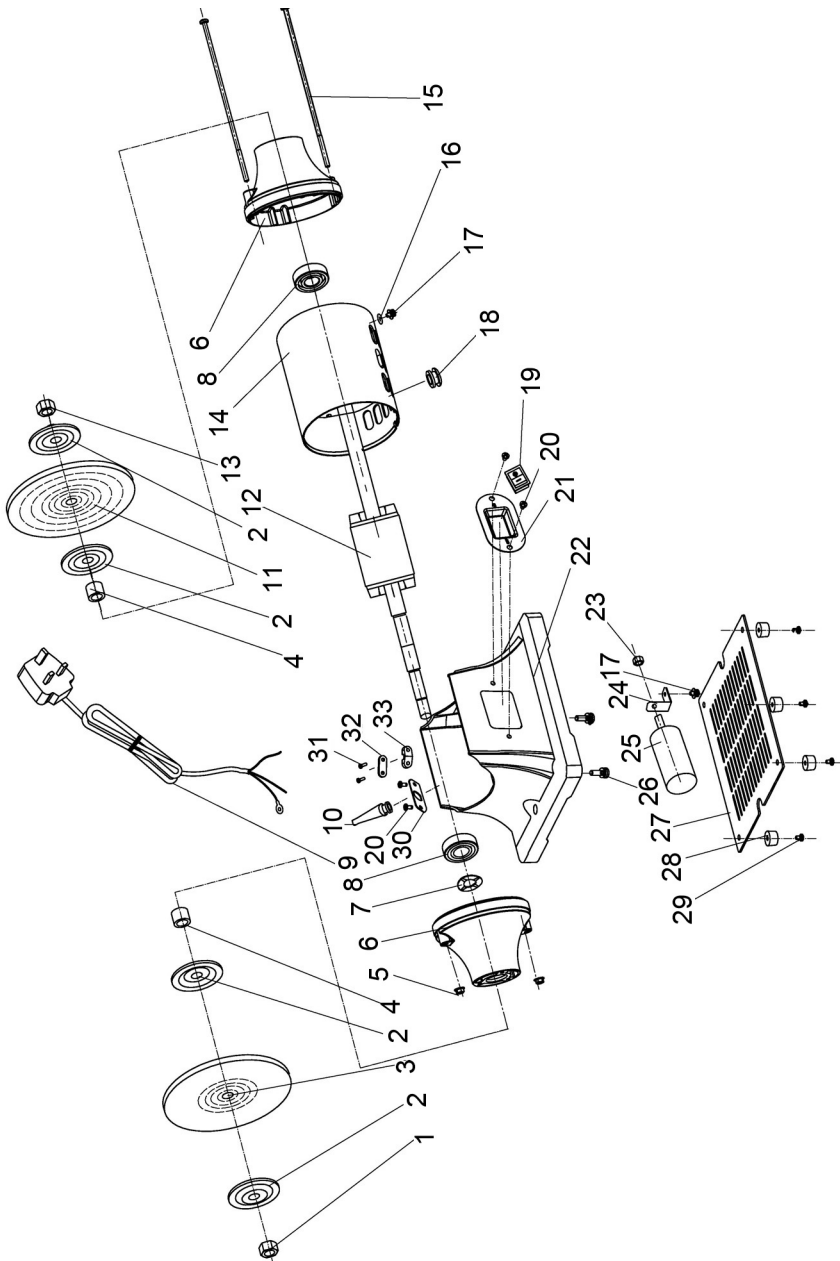

DECLARATION OF CONFORMITY



Clarke[®]
INTERNATIONAL

Hemnal Street, Epping, Essex CM16 4LG

DECLARATION OF CONFORMITY

This is an important document and should be retained.

We hereby declare that this product(s) complies with the following directive(s):

2014/30/EU *Electromagnetic Compatibility Directive.*

2006/42/EC *Machinery Directive.*

2011/65/EU *Restriction of Hazardous Substances, (amended by 2015/863).*

The following standards have been applied to the product(s):

EN 62841-1:2015, EN 62841-3-4:2016+A11:2017+A12:2020, EN 61000-3-2:2014, EN 61000-3-3:2013,

EN 55014-2:2015, EN 55014-1:2017.

The technical documentation required to demonstrate that the product(s) meet(s) the requirement(s) of the aforementioned directive(s) has been compiled and is available for inspection by the relevant enforcement authorities.

The CE mark was first applied in: 2018

Product Description: 150mm Buffer
Model number(s): CBB150
Serial / batch Number: N/A
Date of Issue: 10/11/2020

Signed:

J.A. Clarke
Director

A SELECTION FROM THE VAST RANGE OF

Clarke®

QUALITY PRODUCTS



AIR COMPRESSORS

From DIY to industrial, Plus air tools, spray guns and accessories.

GENERATORS

Prime duty or emergency standby for business, home and leisure.

POWER WASHERS

Hot and cold, electric and engine driven - we have what you need

WELDERS

Mig, Arc, Tig and Spot. From DIY to auto/industrial.

METALWORKING

Drills, grinders and saws for DIY and professional use.

WOODWORKING

Saws, sanders, lathes, mortisers and dust extraction.

HYDRAULICS

Cranes, body repair kits, transmission jacks for all types of workshop use.

WATER PUMPS

Submersible, electric and engine driven for DIY, agriculture and industry.

POWER TOOLS

Angle grinders, cordless drill sets, saws and sanders.

STARTERS/CHARGERS

All sizes for car and commercial use.

PARTS & SERVICE:

0208 988 7400

Parts Enquiries

Parts@clarkeinternational.com

Servicing & Technical Enquiries

Service@clarkeinternational.com

SALES: UK 01992 565333 or Export 00 44 (0)1992 565335

Clarke INTERNATIONAL Hemnall Street, Epping, Essex CM16 4LG
www.clarkeinternational.com